

Quick Start Guide

Rvolution

PlayerMini

English

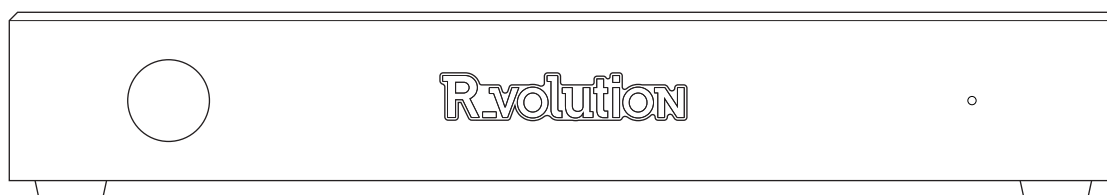

Important Safety Instructions

- 1) Read and keep these instructions.
- 2) Heed all warnings.
- 3) Follow all instructions.
- 4) Do not use this apparatus near water.
- 5) Clean only with dry cloth.
- 6) Do not block any ventilation openings.
- 7) Do not install near any heat sources such as radiators, heat registers, stoves, or other apparatus (including amplifiers) that produce heat.

WARNING:

TO REDUCE THE RISK OF FIRE OR ELECTRIC SHOCK, DO NOT EXPOSE THIS APPLIANCE TO RAIN OR MOISTURE. DANGEROUS HIGH VOLTAGES ARE PRESENT INSIDE THE ENCLOSURE. DO NOT OPEN THE CABINET. REFER SERVICING TO QUALIFIED PERSONNEL ONLY.

THE APPARATUS SHALL NOT BE EXPOSED TO DRIPPING OR SPLASHING AND THAT NO OBJECTS FILLED WITH LIQUIDS, SUCH AS VASES SHALL BE PLACED ON THE APPARATUS.



Warning:

This equipment has been tested and found to comply with the limits for a Class B digital device, pursuant to part 15 of the FCC Rules. These limits are designed to provide reasonable protection against harmful interference in a residential installation. This equipment generates, uses and can radiate radio frequency energy and, if not installed and used in accordance with the instructions, may cause harmful interference to radio communications. However, there is no guarantee that interference will not occur in a particular installation. If this equipment does cause harmful interference to radio or television reception, which can be determined by turning the equipment off and on, the user is encouraged to try to correct the interference by one or more of the following measures:

- Reorient or relocate the receiving antenna.
- Increase the separation between the equipment and receiver.
- Connect the equipment into an outlet on a circuit different from that to which the receiver is connected.
- Consult the dealer or an experienced radio/TV technician for help.

Caution: Any changes or modifications to this device not explicitly approved by manufacturer could void your authority to operate this equipment.

This device complies with part 15 of the FCC Rules. Operation is subject to the following two conditions: (1) This device may not cause harmful interference, and (2) this device must accept any interference received, including interference that may cause undesired operation.

The device has been evaluated to meet general RF exposure requirement. The device can be used in portable exposure condition without restriction.

Getting More Information

Due to the regular evolution and the addition of new functionalities, provided by firmware and software updates, it is impossible to cover all functionalities in this user's guide. For this reason, we invite you to visit our online **R_revolution Knowledge Base**. You will find a large amount of tutorials and various help topics concerning the use of the media player and R_revolution applications:

revolution.com/knowledgebase

About R_revolution

R_revolution designs and manufactures only professional grade Video Management Systems; delivering the highest quality, outstanding performance, and best possible user experience.

All our products are designed to provide our end-user customers with convenient and intuitive access to their entire movie library collection, in stunning 4K, High Definition resolution. R_revolution devices are made to improve the movie watching experience, in residential and commercial environments.

To ensure the ultimate performance, all R_revolution devices are supplied to authorized resellers through a worldwide network of established and well respected partners.

More info: revolution.com



WEEE symbol

Correct Disposal of This Product. (Waste Electrical & Electronic Equipment) Applicable in the European Union and other European countries with separate collection systems.

This marking on the product, accessories or literature (remote handset) should not be disposed of with other household waste at the end of their working life. To prevent possible harm to the environment or human health from uncontrolled waste disposal, please separate these items from other types of household waste and recycle them responsibly to promote the sustainable reuse of material resources.

More info can be found here:

<http://ec.europa.eu>

CAUTION:

DANGER OF EXPLOSION IF BATTERY IS INCORRECTLY REPLACED. REPLACE ONLY WITH THE SAME OR EQUIVALENT TYPE. DO NOT OPEN COVERS AND DO NOT REPAIR YOURSELF. REFER SERVICING TO QUALIFIED PERSONNEL.



CE mark

This product complies with European Low Voltage (2006/95/CE), Electromagnetic Compatibility (2004/108/EC) and Environmentally-friendly design of Energy-related Products (2009/125/EC) Directives when used and installed according to this instruction manual.

Table of Contents

English Quick Start Guide

- 3 • General, Key features
- 4 • Organize your video library with movie covers
- 5 • Package Contents
- 6 • Exterior (Front view, Rear view, Right view)
- 7 • Remote control, home automation (IR / IP control)
- 8 • How to connect the player to a TV without AV Receiver
- 8 • How to connect the player through AV Receiver
- 9 • Optical S/PDIF digital audio, HDMI eARC
- 10 • Ethernet
- 10 • Network switch
- 10 • Wi-Fi
- 11 • Connect a NAS
- 12 • Getting started
- 12 • Audio settings
- 12 • Video settings
- 13 • How to connect, format and use a hard drive
- 14 • Explorer, R_video, Create a R_video account
- 15 • Network access
- 15 • File management
- 15 • Slideshow function
- 15 • Playback options
- 15 • Install an Android app
- 16 • How to create a movie collection in R_video
- 17 • R_video home page
- 17 • Identify a film or TV show
- 17 • Delete a movie or episode
- 18 • How to identify unidentified films and episodes
- 18 • Top banners
- 18 • How to change an image (cover or wallpaper)
- 18 • Multiple hard drives
- 19 • Parental control
- 19 • Personal categories
- 19 • Launching R_video on startup
- 19 • Filters and Sorts
- 19 • Search engine
- 19 • Sagas and groups
- 20 • Options for displaying subtitles during playback
- 20 • Subtitle download options
- 20 • Video zoom and aspect ratio settings
- 20 • Technical information during playback
- 20 • R_video collection statistics
- 20 • Add a category to the left bar
- 21 • Firmware update
- 21 • Factory reset

General

The Revolution PlayerMini is a universal media player compatible with HDR10, HDR10+, Dolby Vision that offers HDMI 2.1, USB 3.0 port and AV1 UHD 4K support up to 60p.

Key Features

- **Processor:** Amlogic S905X4-K.
- **CPU:** 2.0 GHz ARM Cortex-A55 (4-core).
- **GPU:** Mali-G31 MP2.
- **Memory:** 1MB L2 cache, 4GB RAM, 32GB ROM eMMC NAN.
- **HDR:** Display your HDR, HDR10+ and Dolby Vision video content on a compatible display.
- **Video Processing:** Dolby Vision VS10 video processing for the best picture possible.
- **HDMI 2.1a:** Display up to 8K UHD resolution, 8x more pixels than 1080p Full HD resolution.
- **4K UHD:** Display your 4K 50p/60p video content in HD or 4K resolution at 50 Hz or 60 Hz.
- **MKV Player:** Playback SD, HD and UHD video contents in MKV, M2TS, DVD / BD / UHD ISO and other modern video file containers and formats, including top quality AV1/HEVC/H.265 video codec, with very high bitrates up to 300Mbps.
- **Network Player:** Connect your media player on your local network and enjoy your content from a computer PC/MAC or a NAS via SMB.
- **USB Ports:** Conveniently connect hard drives, external drives up to 32TB, USB flash drives, USB card readers, computer mouse, and other USB devices.
- **USB Port 3.0 x2:** Read or copy your files at ultra high speed.
- **Full Range of A/V Connectors:** S/PDIF optical audio output, HDMI 2.1 output.
- **Multichannel home cinema audio:** Bitstream (RAW), downmix LPCM stereo.
- **Video Output Flexibility:** Output video in any resolution and format from up to 4K Ultra HD (3840×2160). Display your movies in true 24p (23,976 Hz output).
- **Auto Framerate:** Auto framerate detection 24/50/60p (compatible 24.000 Hz / 23.976 Hz).
- **Playback Memory:** Resume playback from last position.
- **Advanced File Browser:** Convenient file browser with powerful file management (select, select all, copy, cut, past, delete, rename, ...).
- **Backlit Remote Control:** High quality remote control with direct access and shortcuts with backlit buttons and recordable buttons to control another device.
- **Wi-Fi 6 with 2 removable antennas:** Play and transfer your video content wirelessly (IEEE 802.11ax) with high bitrate.
- **Widevine L1 DRM:** Watch premium online video services in HD and UHD.
- **SACD (DSD):** Play top quality Super Audio CD (DSD) music files in all any popular formats (ISO, DFF, DSF), including both stereo and multichannel files as well as files using DST compression.



Manufactured under license from Dolby Laboratories.
Dolby and the double-D symbol are trademarks of Dolby Laboratories.



DTS, the Symbol, & DTS and the Symbol together are registered trademarks & DTS 2.0+Digital Out is a trademark of DTS, Inc. Product includes software. © DTS, Inc. All Rights Reserved.

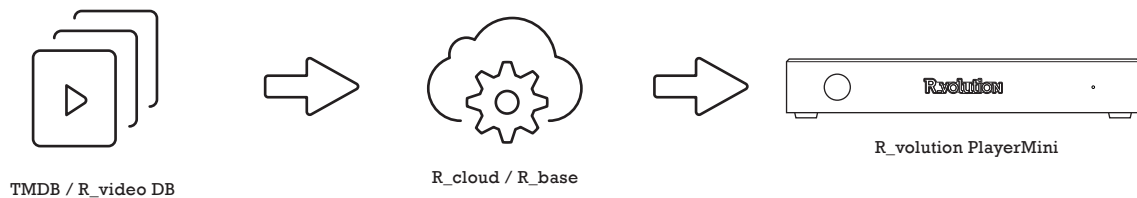

Organize Your Video Collection With Movie Covers

- **R_video Interface:** Browse your movie and TV show collection with cover art and media information: (subtitles, actors, director, release date...). R_video features an automatic category index of movies and TV shows directly to the player, without the need of a computer.
- **R_search:** Easy access to your movies or TV shows, thanks to R_video powerful search engine combined with smart filters (actor, director, running time, rating, release date...).
- **R_video Stand-Alone:** Add, edit or delete movie covers directly on your R_revolution player using the remote control (no PC required). Change the posters, edit the synopsis, change the associate category, create and organize your own personal categories, etc.
- **R_video on Start-up:** Enable/disable launching R_video from system startup in settings.
- **R_share:** Share video content from a R_revolution Player with other players in your home.
- **Parental Control:** With the parental control feature, you can designate movies as "children's" and block access to other movies with a PIN code. Thus, your children can safely access only their movies! In addition, the child mode provides direct access to movies for greater ease of use.
- **Movie Sagas:** The saga films are automatically placed in groups and sorted by release date. A saga cover dedicated to the collection is associated with the group.
- **Automatic Seen Status:** Your films and episodes are automatically marked as "Seen" or "Ongoing" status. And when you finish watching a TV episode, R_video automatically offers to launch the next one !
- **Subtitle Download:** Conveniently download subtitles directly from the R_video interface.
- **R_video Next:** Direct access to the current or next episode / film of a saga directly from the R_video home page.
- **R_video Soundtracks:** With the amazing R_video Soundtracks, you can explore your collection, while listening to the soundtrack associated with your movies, TV shows and sagas.
- **R_video Off-line:** Save a collection locally and use it without any Internet connection.
- **R_video Trailers:** Watch the trailer of your movies.
- **R_sync:** Thanks to R_sync, your movie collection is automatically synchronized with your other R_revolution players.
- **R_revolution Explorer:** Explorer is the easiest way to start playing most media files such as UHD, BD and DVD ISO, BDMV, M2TS, MKV, MP4, MOV, MP3, FLAC, JPG... R_revolution Explorer makes file exploration so easy !

Package contents



1

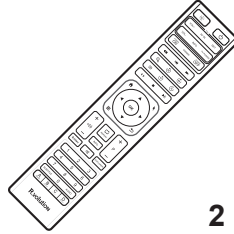

2

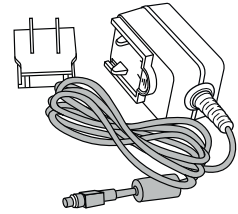

3



4



5

1. R_volution PlayerMini
2. IR Remote Control
3. Power Adapter
4. RF Antenna
5. Wi-Fi Antennas

NOTE: Additional items (optional) may be included into the package, depending on player configuration, region, and distributor.

Front View

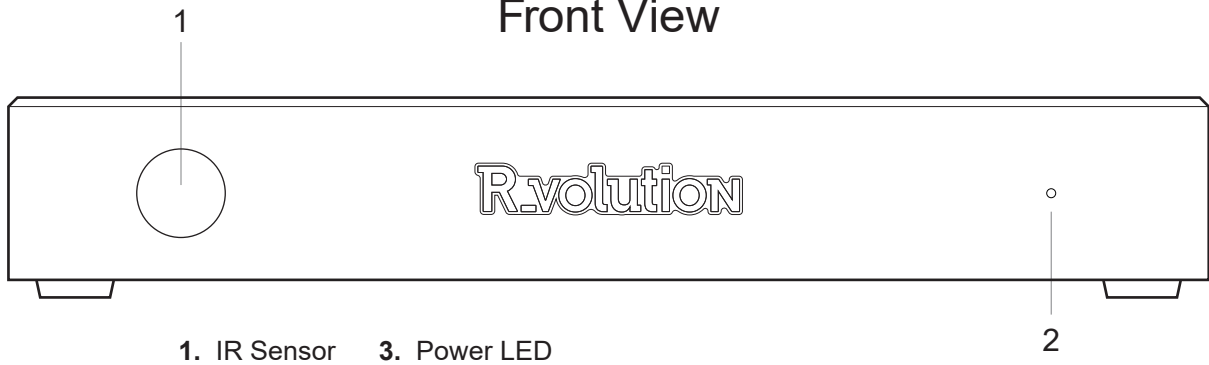

Right View

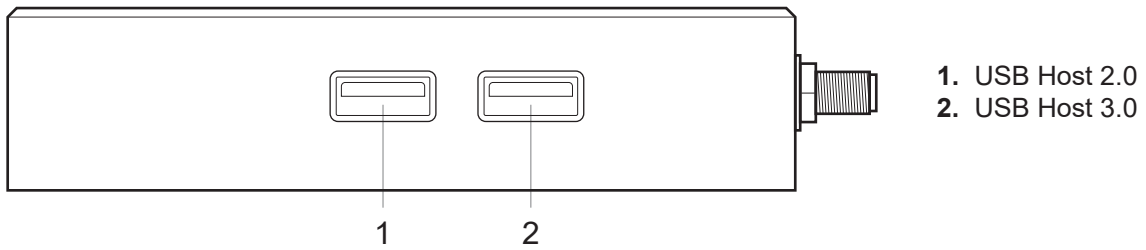

Rear View

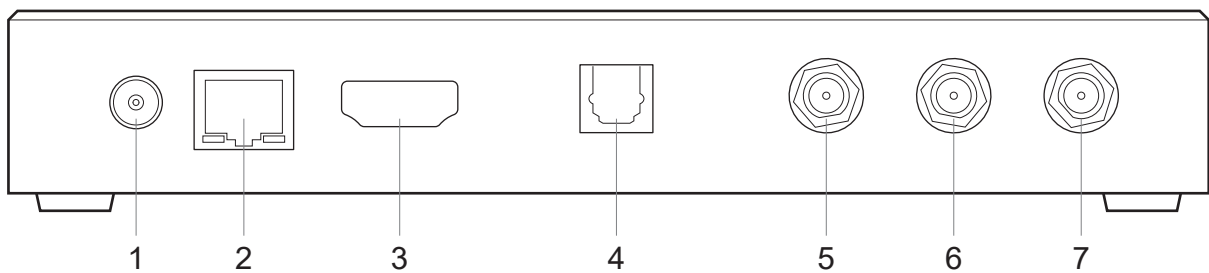

1. DC Input for External Power Supply 12V ≥3A
2. LAN 10/100/1000 (Ethernet)
3. HDMI AV Out
4. Optical Digital Audio Output
5. RF Antenna
- 6-7. Wi-Fi Antennas

Remote Control

1. **LIGHT:** Turn on the backlight of the remote control.
2. **POWER:** Toggle power ON/OFF.
3. **TV SECTION:** Programmable buttons to control TV or other external device.
- 4-5. **POWER ON/OFF:** Discrete power ON/OFF.
6. **DIMMER:** Toggle front LED screen ON/OFF.
7. **DELETE:** Delete the previously entered character.
- 8-9. **PREV/NEXT:** Go to the previous/next chapter.
10. **ZOOM:** Zoom In / Out (overscan).
- 11-12. **-60/+60:** Timeline navigation (-/+ 60 sec.).
- 13-14. **-10/+10:** Timeline navigation (-/+ 10 sec.).
15. **MODE :** Safe video mode.
16. **< >:** Go to playback position.
17. **STOP:** Stop video playback.
18. **PLAY/PAUSE:** Start / Pause playback.
- 19-20. **UP:** Next file (Explorer). **DOWN:** Previous file (Explorer).
- 21-22. **LEFT/RIGHT:** Timeline navigation (-/+1 min).
23. **HOME:** Go to Main Menu (Home Page).
24. **MOUSE:** Switch to the virtual mouse mode.
25. **MENU:** Show / Hide the pop-up menu.
26. **BACK:** Return or Stop playback.
- 19-22. **ARROWS:** Navigate menu selection.
27. **OK:** Enter or validate the current item.
Long-press : show the on-screen playback menu.
- 28-29. **VOLUME +/-:** Increase / Decrease volume.
30. **REPEAT:** Repeat playback (file, all, off).
31. **INFO:** Show / Hide the pop-up info (properties).
- 32-33. **PAGE +/-:** Timeline navigation.
34. **R_VIDEO:** R_video shortcut.
35. **MUTE:** Mute audio.
36. **EXPLORER:** R_olution Explorer shortcut.
37. **NUMBER Buttons:**
 - 1-9: direct access to 10-90% (video playback or movie list).
 - 0: Restart from the beginning (video playback or movie list).
38. **SUBTITLE:** Subtitle switch.
39. **AUDIO:** Audio track switch.
40. **RED (A):** Contextual shortcut.
41. **GREEN (B):** Contextual shortcut.
42. **YELLOW (C):** Contextual shortcut.
43. **BLUE (D):** Contextual shortcut.

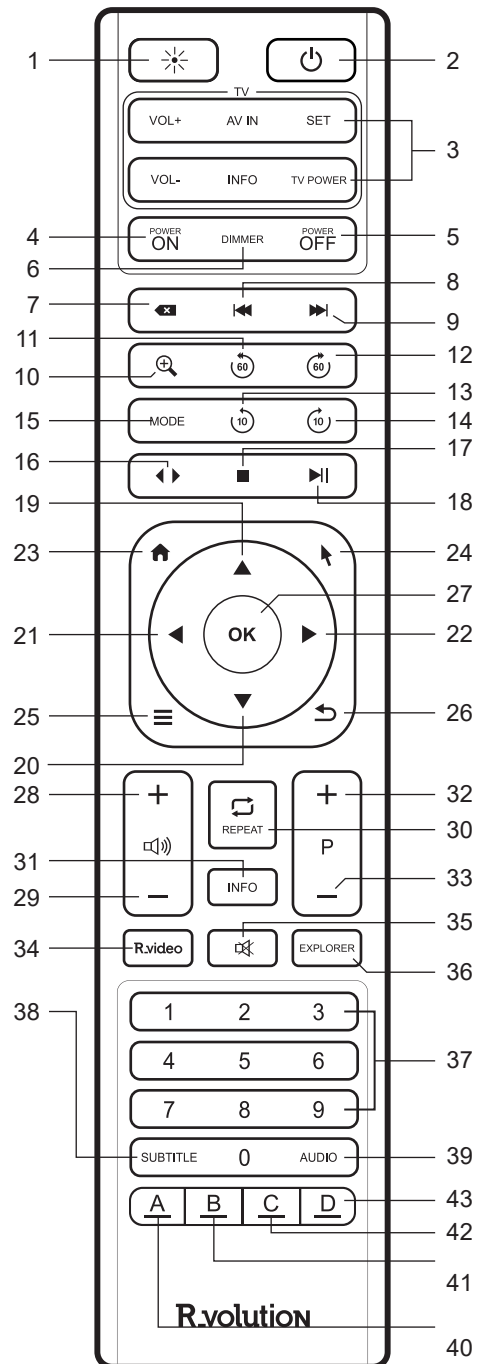

Using the Remote Control



When using the remote control, the front window of the remote control should be pointed to the infrared sensor on the front panel within an angle of $\pm 60^\circ$ and a range of about 26 ft.

*Please use alkaline batteries.
Please observe polarity when inserting batteries.*

Third Party Control

You can control your R_olution player using third party devices such as Control4, Crestron, RTI, ProControl, Savant, Logitech, Elan...

More info:
rvolution.com/knowledgebase

Connecting your Player to your TV without AV Receiver

If you don't own a home theater receiver or soundbar, the most convenient and easiest way is to connect your player directly to your TV. To do this, connect the HDMI output of your media player to an available HDMI input on your TV.

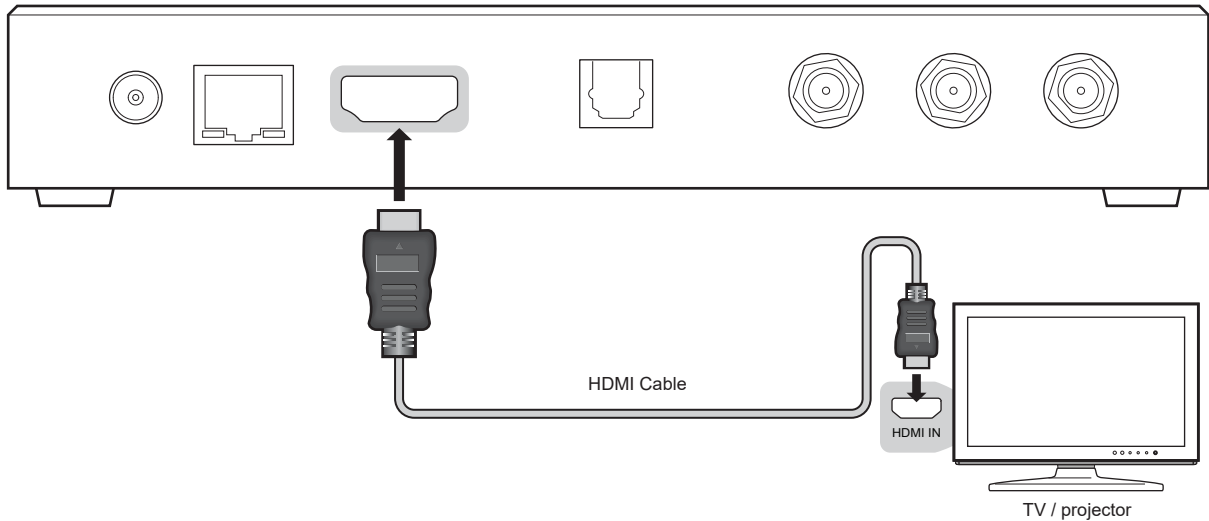

Connecting your Player to your TV through AV Receiver

If you own an AV receiver, the most convenient and easiest way is to connect your media player to your TV through your AV receiver or soundbar. To do this, connect the HDMI output of your media player to an available HDMI input on your AV receiver. Then connect the HDMI output of your AV receiver to your TV or front projector. If your TV is compatible with 4K HDR, your AV receiver must also be compatible with 4K HDR. Otherwise, please use the S/PDIF optical output or the eARC HDMI output as explained on the next page.

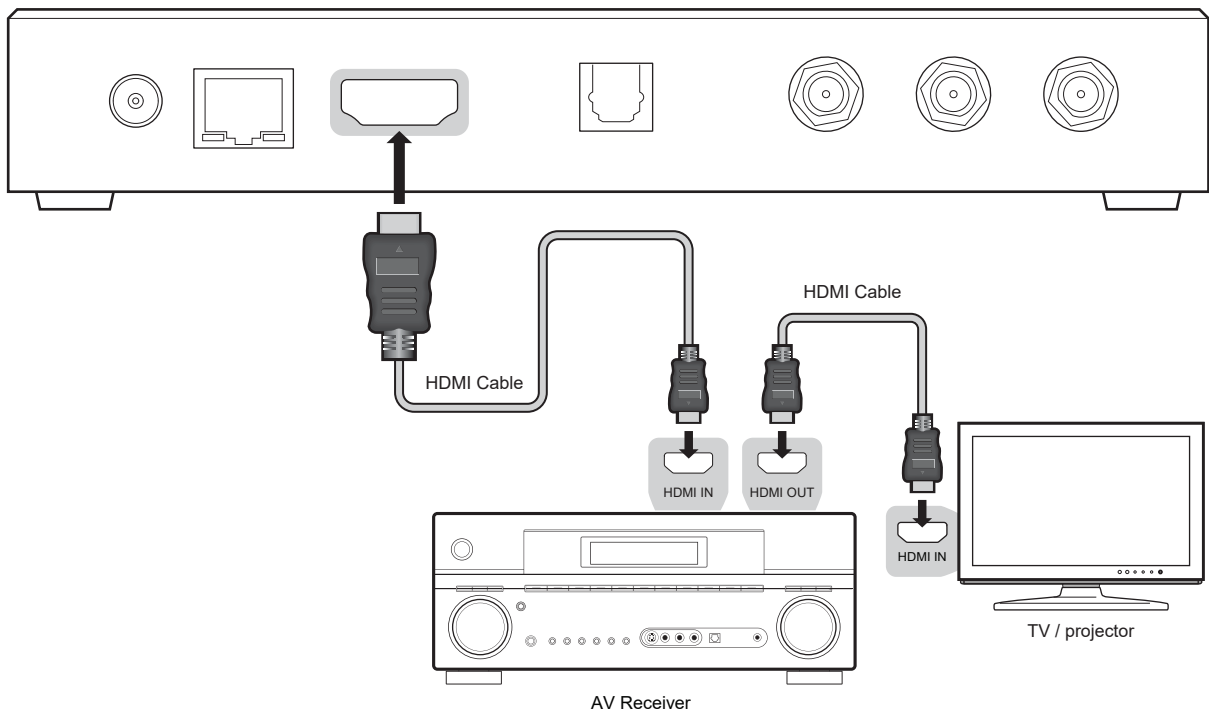

Audio Digital S/PDIF Optical

If your AV receiver is not compatible with HDMI, you can connect your player to your AV receiver using S/PDIF optical (TOS-link) output as follows:

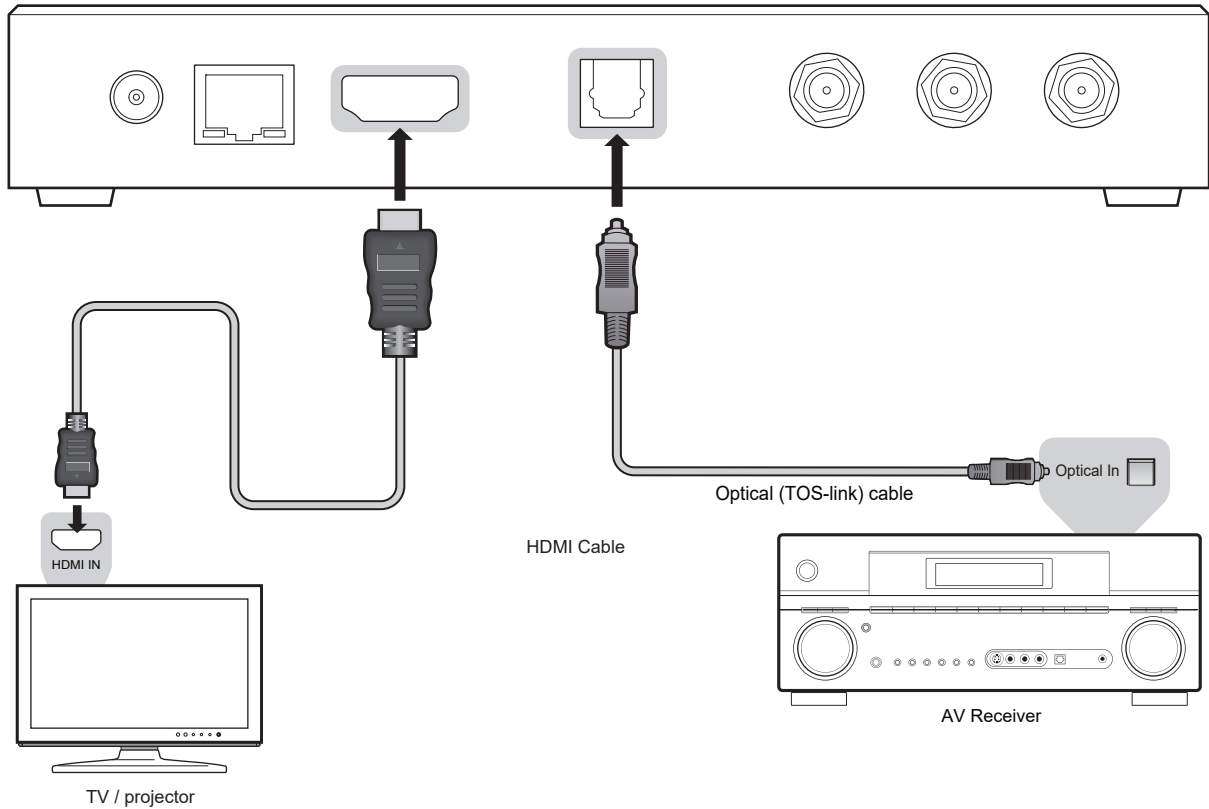

HD Sound



S/PDIF can carry two channels of uncompressed PCM audio or compressed 5.1 surround sound (such as DTS or Dolby Digital codec); it cannot support lossless surround formats that require greater bandwidth like DTS-HD or Dolby TrueHD.

Black Border & Overscan



If you get a black border issue all around your TV screen, please go to your Tv settings and set the correct aspect ratio option to remove the black border. (**Fit to Screen** option).

HDMI eARC



If your TV is compatible with eARC, you can also connect your media player to a HDMI Input of your TV and connect your AV receiver to the HDMI eARC output.

Ethernet

The media player provides two network connection methods: through Ethernet cable or through the built-in wireless LAN adapter. For the fastest and most stable network connection, we recommend using an Ethernet cable whenever possible. Plug one end of a network cable (straight Ethernet cable) into the **LAN port** on the back of the media player (Category 5E or more). Then, plug the other end of the network cable into a LAN port on the broadband router or modem (or switch if you use one).

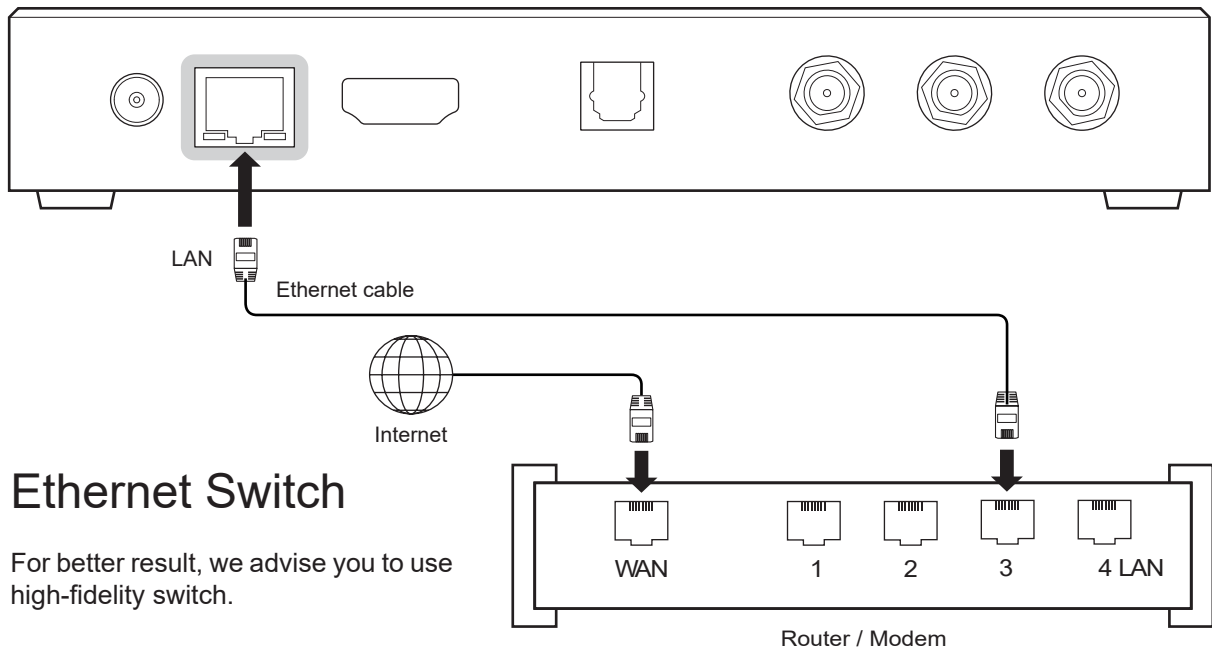

Ethernet Switch

For better result, we advise you to use high-fidelity switch.

Wi-Fi

To setup the wireless feature, start by connecting the antennas to the Wi-Fi connectors on the back of the media player. Then, turn on your media player and go to: **Setup > Network > Wireless connection (Wi-Fi)**. Then click on Edit settings. You will be able to select a wireless network and enter the security password.

If you own a R_revolution NAS or any other NAS, please connect the devices as follows:

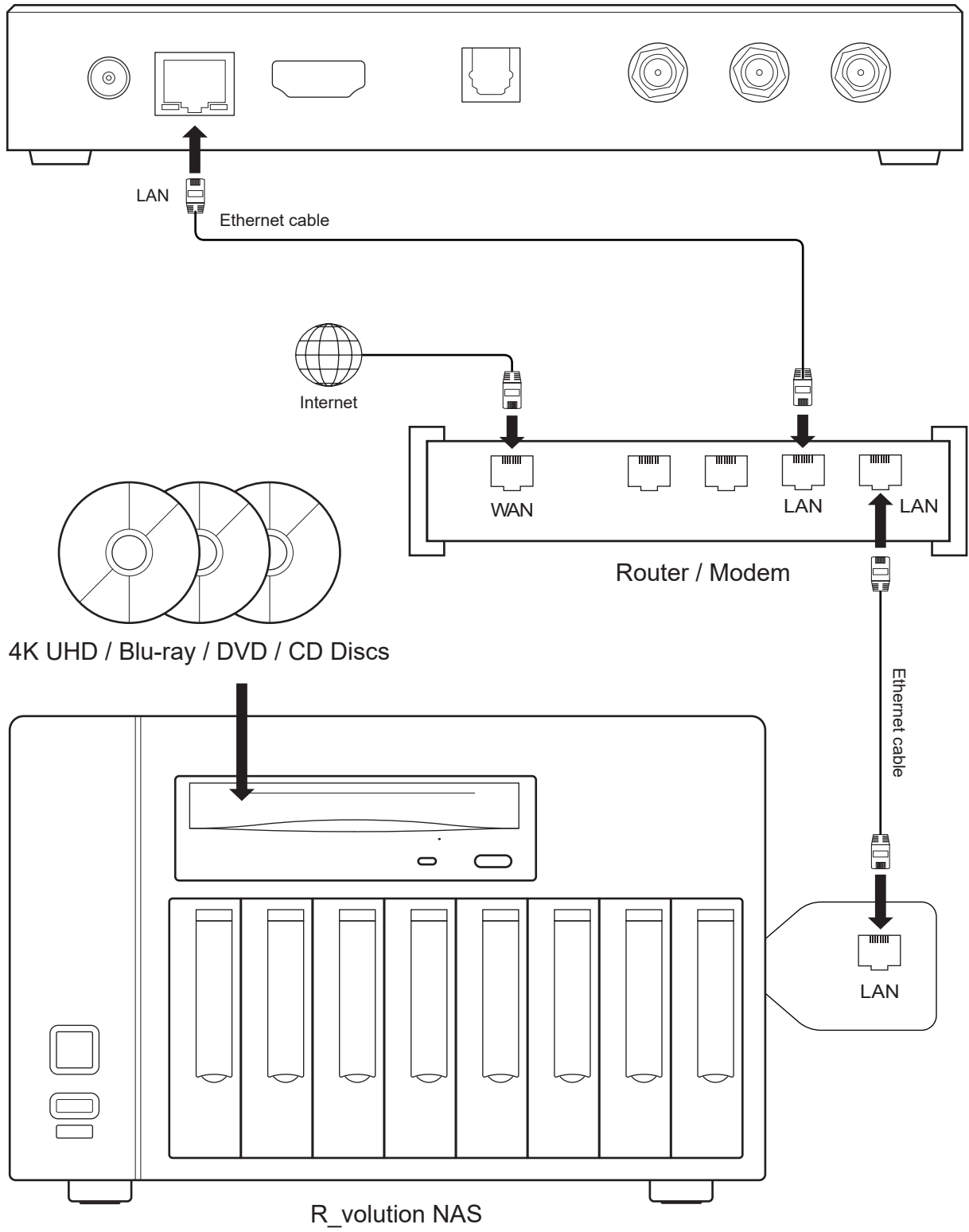

Getting Started

- ⚠ **Use the HDMI OUT output to connect your player to your TV or video projector.** Plug in and turn on the media player. The player will go through its initial start-up procedure (takes less than one minute).
- ⚠ **If you experience a black screen or no video signal, please consult the following knowledge base:** revolution.uservoice.com/knowledgebase

You will then be taken to a quick setup screen. Follow the steps to set the language, resolution, and network access.

Finally, you should see the main screen with access to the Video (R_video Media), and Explorer applications, among others, as well as **Setup** and **Android Apps**.

To set the default language for audio tracks and subtitles for video content playback, go to **Setup > Playback** and choose your preferred default language for audio tracks and subtitles.

Audio settings

The **Audio** section of the **Settings** menu allows you to set preferences for audio output formats. If you are using an HDMI compatible multi-channel AV receiver, please set the **Digital Audio Connector** option to **HDMI (HD Audio On)**. If your home theater amp / preamp is not HDMI compatible, set the **Digital Audio Connector** option to **S/PDIF (HD audio off)**.

We recommend that you set the **Digital audio output mode option** to **Auto**. But it may be a good idea to select **PCM** mode (with decoding) for certain types of audio formats like AAC if your AV receiver cannot decode this format. **Bitstream** mode always sends the audio stream to your AV receiver in an undecoded way. But in this mode, some audio formats may not work if your AV receiver does not support these formats.

In order to listen to music in lossless or uncompressed format, you can set the **Maximum digital output sample rate** option to **192kHz**. However, please be careful because this mode can generate crackling in the speakers if you use an incompatible 192kHz amplifier or soundbar, or if you do not use an amplifier or soundbar at all (sound from the TV). In this case, select the **Auto** option.

Video settings

By default, the player automatically adjusts the video output according to the resolution of your television. It is strongly recommended to leave the resolution settings in **Auto** mode (in **Setup > Video**). If your TV or projector is compatible, we recommend the **Y'CbCr 4:4:4 / 10-bit** or **12-bit** mode for the best video performance. **Warning!** *The higher you move up in the video output specifications, the higher the bit rate will be and will require a quality cable.*

HDR

To benefit from the best performance on HDR content, we invite you to go to **Setup > Video > HDR and Dolby Vision settings** and select **Dolby VS10 processing for HDR, DV video**, in the **HDR processing mode** option instead of Auto.

External Drives

If you are using a 2.5" external hard drive, please use the USB cable that came with your hard drive for best performance.

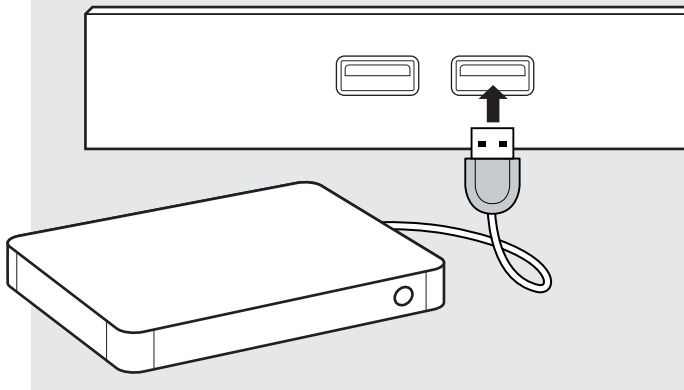

External HDD

Connecting USB Drives

Connect your USB drives to one of the available USB ports. If you want to play video files, USB 2.0 is enough to support very high speeds (up to 300 Mbps). If you want to transfer files, we recommend using **USB 3.0 ports for faster transfers**.

The power supplied by the USB ports may not be enough to allow the external drive to function properly; depending on the hard drive, especially for large capacity drives. In this case, please use a docking station.

Please do not disconnect or turn off the USB external drive during writing operations such as copying or transferring files.

*The player is compatible with **UASP HDD docking stations** as well as **USB hubs**.*

Using External Drive

The media player is compatible with drives formatted in FAT16 or FAT32 (read-write), EXT2/EXT3/EXT4 (read-write), NTFS (read-write), exFAT (read-write), HFS/HFS+ (Mac standard OS /Extended) (read-only), BTRFS (read-write). It is possible to **format** your hard drive via Explorer via **Menu > Format**.

Large capacity drives

The media player supports partitions up to 32TB. It can also format partitions up to 16TB via Explorer. To use hard drives larger than 16TB, use formatting software on your computer to format your hard drive.

More info: revolution.com/knowledgebase

Use the RC buttons UP, DOWN, LEFT, RIGHT, OK, RETURN to navigate through the player menu. Use the **MENU** RC button to show the list of available commands. Use the **INFO** RC button during playback to show the INFO panel (duration, resolution, framerate, bitrate, etc.).

The Home Page features 2 main applications: **Explorer**, and **Video**.

Explorer

Explorer is a File Manager. You can easily explore and launch playback of your music, pictures and video content. But Explorer is more than just a file explorer — it also provides many advanced multimedia features and a complete file management system.

R_video

R_video is a media player, software and entertainment hub, featuring an impressive user interface with movie covers. With R_video, you can experience your entire movie and TV series collection, browse and play your titles from local and network storage media, view cast information, download subtitles, play trailers and much more.

In order to start using the R_video app, you have to create a R_revolution account and register your device. First, connect your media player to Internet through Wi-Fi or Ethernet. Launch R_video and select your language. Then, follow the on-screen instructions. If you have never used R_video before and if you don't have any R_video account, please click on **Create an account now**.

Login

The login screen contains the following elements:

- An input field labeled "Email".
- An input field labeled "Password".
- A button labeled "Login".
- A button labeled "Create an account now", which is highlighted with a black arrow and the text "Click here to create a R_video account".
- A button labeled "Return".
- A button labeled "Forgotten password?".

Then you will be prompted to enter your R_revolution Token number. The Token number is printed on a sticker located under the media player. You will only have to enter it once. Then all your account information will be saved in the internal memory of the media player. R_revolution needs this information in order to be able to register your collection (only the covers, not the films). The R_cloud allows you to preserve your collection*. In the event of a device failure, or the purchase of another R_revolution player, all you need to do is enter your credentials to access your collection and recover everything identically. R_cloud also offers a multiroom feature called R_share to access your collection of movies, concerts and TV shows from other R_revolution players in the house.

**for more info regarding the cloud service terms and conditions, please visit the official web site.*

Accessing Network Drives and Access to The Player

This media player features a Samba client (SMB) to explore and playback your videos, pictures and music, located on your local network (NAS, computers, ...). The SMB Server is activated by default. You can access your media player entering **\\R_VOLUTION** in the explorer of your computer or using the media player IP address as following: **\\192.168.1.15** (for instance). Then, enter **guest** as login and password. *In order to find the IP address of your player, go to: **SETTINGS / Ethernet Configuration**.*

More info about network access here: rrevolution.com/knowledgebase

The media player also features a function called **R_share**, based on Samba server technology. This allows you to access your video, pictures and music content, located on internal HDDs (or local drive connected in USB to the media player) from another R_volution player through your local network. You can playback video contents, in up to 5 different rooms simultaneously (up to 2 in UHD resolution), equipped with R_volution media players. Thanks to **R_share**, a NAS server or computer is not required to stream your media content in different rooms in your home. To use R_share, please select **R_share** instead of **Local drive** in the **Folder settings** of **R_video**.

File Management

In addition to be a file browser, Explorer is also a complete file manager offering functions such as: Copy, Cut, Paste, Select, Select All, Delete and Rename. To access these functions, press the **MENU** button of the remote control.

Slideshow Function

Explorer also offers a slideshow function with cross fades and transition effects. To manage the **Slide show delay** and **Transitions effect**, go to **Setup > Playback > Photo Viewer**. To access the Zoom options, press **Zoom** button. Then, press **1 time** for **Fit to Screen**, **2 times** for **Pixel to Pixel**, **3 times** for **Custom options**. Then, use **P+/-** to **Zoom In/Out** and **Arrows buttons** to move the focus. Press **Pause** button to pause the slideshow and press **Play** to **pause/play** the slideshow. Press **OK** to display the list of the pictures and direct access to any one of them. On this screen, press **7** for **Repeat** and **8** for **Shuffle** options.

Video Properties

To view the complete technical information of the file being played, press the **INFO** button on the remote control. You will find in particular, the datarate, framerate, video & audio codec and format, size, resolution, and more...

Video and Audio Playback Options

During playback, the **MENU** button on the remote control provides access to various video and audio playback options such as direct access to a precise playback position in time, zoom and ratio options, etc.

R_volution NAS Stats & options

The R_video **MENU** provides access to the statistics of the R_volution NAS (temperature of the drives, available space...) as well as music encoding options (MP3, AAC, and FLAC).

How to Install a New App

To install a new app, please go to **Android Apps / AptoideTV**. You'll find many apps dedicated to media players that can be controlled by RC. You can also use **GooglePlay** but some apps may not be compatible with this media player. If you want to install an **APK** from a USB stick, please use **Explorer**.

How to Add a Favorite

To add movie or a folder as favorite, press **Menu** and select **Add to favorite** to add it to the favorite section.

How to Create a Movie Collection in R_video

Before starting, you must create a folder named **MOVIE** on your HDD. Then, place all your movies inside this folder. If you have TV shows, place them in a dedicated folder named **TV SHOWS**.

Movies

1. On your NAS or HDD, please create a movie folder named **MOVIES**. Place all your movie files in it.
2. Your files should be named with the title of each movie. For example, the file of the movie "Metropolis" should be named "Metropolis.mkv". You can create subfolders in the folder **MOVIES** if you want.

TV Shows / TV Series

1. On your NAS or HDD, please create a folder named **TV SHOWS**.
2. Then, create a subfolder for each TV Shows. You can create a subfolder for each season if you want. Then, place all your TV Show episodes in it.
3. Your episodes must be named as: "TVShowName s01e01" ("TVShowName 1x01" also supported). For the special episodes, please name them as: "s00e01".

Connection

Accounts	<input type="text" value="my.email@mailbox.com"/>
Servers	<input type="text" value="R_cloud"/>
Collections	<input type="text" value="Collection 1"/>

Start your player. On the main page, click on the first button named **VIDEO**. Choose your language and enter your login. *If you do not have any R_video account, please go to the page 14.*

Then, click on the button **Connection** located on the bottom of the window.

On the **Folder configuration** window, please click on **Add a folder containing movies** (or TV Shows). If your files are located on a local storage, please click on **Local drives**. If you want to share your video contents with others R_volution players through your local network, click on **R_share**. Then click on the storage name. Next, browse it and go inside the Movies (or TV Shows) folder. Finally, when you are in the folder **MOVIES** (or TV SHOWS) click on **Add this folder** button located on the top of the window.

WARNING! Do not add all your subfolders. You should just add your "MOVIES" folder containing all your movies. If you own a NAS, please place your folders MOVIES and TV SHOWS inside the shared folder VIDEO. Do not place your folders MOVIES and TV SHOWS in the root folder of your NAS.

Your folder will be added in the MOVIE folder list (or TV SHOW). You can check the path by looking on the **generated path** located between "MOVIES" button and **EDIT** button. Your path should stop to the "MOVIES" folder (or "FILMS" folder). If your path is incorrect, you can modify it by using the **Edit** button. Press **Delete** button to delete the folder from R_video. (*Don't worry! Your movies will not be deleted*). If you want to add another folder containing movies or TV Shows, please click on the dedicated button.

Folders

<input type="button" value="Movies"/>	/storage/HDD/Films	<input type="button" value="Edit"/>	<input type="button" value="Delete"/>
<small>Storage ID: fs3sho54suey-ya55h4st7e-syot563lj3a</small>			
<input type="button" value="Add a folder containing movies"/>			
<input type="button" value="Add a folder containing TV shows"/>			
<input type="button" value="Add a folder containing personal movies"/>			

Then, press **RETURN** if you don't want to add another folder containing movies. R_video will start to scan your folders and analyse your video contents. You can see the current scan task in a dedicated panel. To close the current task panel, press the **RETURN** button of your RC. If you close it, you can display it again through the **MENU** button of your RC.

Done! Now you can enjoy your R_video collection! To access the configuration panel again, press the **MENU** button on your remote control. In the configuration panel, you'll find many options such as: language (GUI and identification), number of poster lines, top movie cover, parental control, identification on startup, terms to exclude, token and other account administration.

More info here: rvolution.com/knowledgebase

R_video

The R_video homepage is made up of 2 parts. The left part offers access buttons to modules. By default, some modules are displayed, such as: **ALL, MOVIES, SERIES, RECENT, CATEGORIES, ...** It is possible to delete or add modules using the **MENU** button on the remote control. It is also possible to display the contents of a module or category of your choice in the main part (showcase). By default, the **NEXT** module is proposed. This module displays the movies or episodes currently playing. In case you have completed a TV episode, the following episode is proposed. In the case of a saga, the following movie is displayed. To delete an episode or movie from the **NEXT** module, select it and press the **MENU** button and click **Remove from Showcase**.

/storage/HDD/Films
Storage ID: 0000000000000000

If you get a wrong storage ID with « 0000000000 », it means that R_video cannot write on the drive due a defective disk sector. Please format it again.

To access additional features, press the **MENU** button of your RC.

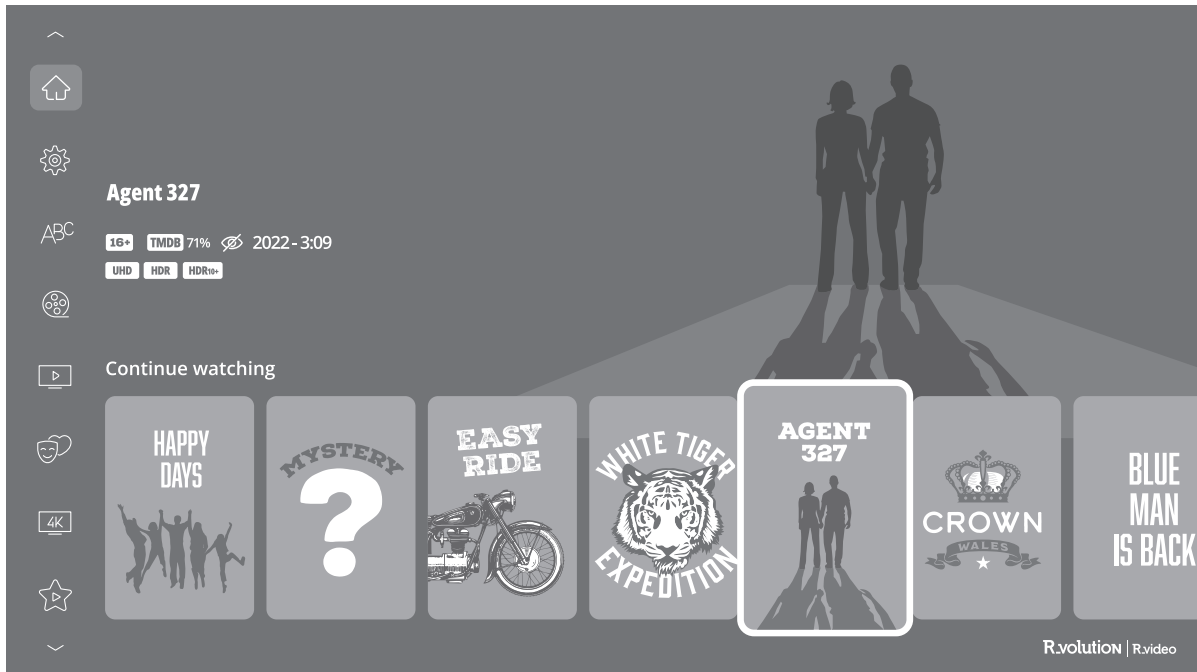



How to Identify a Movie / Episode

When you add a movie file to your **Movies** folder, R_video will automatically index it at the next restart of the application. To force the identification process, press **MENU** of your remote control, then click on **Identify** option.



Identification



-  Start identification ←
-  No video to identify

How to Delete a Movie / Episode

When you delete a movie file from your 'Movies' folder, R_video automatically removes its cover and descriptive page from your R_video collection during the next analysis. You can manually remove a movie using the **Delete** option located in the R_video menu (contextual actions).



Edition

-  Delete... ←
-  Categories

How to Identify Unidentified Movies & TV Shows

Even if your files are not named correctly with the title of the film (or TV show), R_video can identify it but only if a R_video user previously identified it manually. If you are living in a country where R_video is not yet popular, which could have happened often at the beginning, mostly if you are using a R_volution NAS Rip because the generated files are rarely named correctly. But day after day, R_video DB will become more and more reliable as users manually identify movies and TV series files.

Press **MENU** of the RC and select **X to Identify**. You'll see the list of the files that are not identified. Then, click on the button named **Identify...** On the **Identify window**, please enter again the movie title.

You can also enter the TMDb ID code to identify your movie or your TV show. On TMDb website, the ID code is located in the URL of the movie page. For instance, the URL of the movie "Charade" will be "https://www.themoviedb.org/movie/**4808**-charade". Enter the ID number "**4808**" in the dedicated field instead of the title. Then press the "Search" button. R_video will find the right movie 100%. If your movie or TV show does not exist on TMDb, you can add it directly by creating an account. Please note that the validation of new film, concert or TV series listings on TMDb may take approximately 24 hours before appearing on R_video due to the moderation period.

Top Banners

A top banner is automatically added to 4K UHD, Blu-ray and DVD files. But you can add manually a special banner to the top of your movie covers. R_video offers so many additional covers such as 4K Ultra HD Disc-1 / 4K Ultra HD Disc-2, 4K Ultra HD Director's Cut, 007, DC, THX, IMAX, DVD Special Edition, DVD Superbit, Laserdisc, D-Theater, etc.

To change the top banner, go to :

Menu > Edit > Additional top banner > Custom.

How to Change a Picture (Poster or Background)

To change the poster or the background of a movie or TV show, press the **MENU** button of your remote control, then click on **Change the picture** option using the **OK** button of your R_video remote control. Then, click on the poster or background of your choice. If you see a R_video DB banner, it means that this picture is part of R_video movie cover database.

Multiple Hard Drives

R_video is able to mix the content of several sources. For instance, one collection can contain movies located on 2 hard drives and one NAS. If you are using multiple hard drives, R_video is able to detect if the drives are accessible or not. When you launch a movie but the drive containing the movie is not connected, R_video will show a popup window asking to insert the dedicated drive.

Parental Control

To tag a movie as **Allow for children**, select a movie (or a group of movies), then press the **MENU** button on the RC and click on **Allow for children**. Then, enter a 4-digit pin code.

Parental code

Please enter a 4-digit pin code.
This code will allow you to lock your collection and restrict access to movie tagged "Allowed for children".



Personal Categories

By default, the movies and TV shows are automatically associated to categories. But you can create your own categories and associate manually your movies. To create a category, go to **Categories**, then press **MENU** and click on **Create a category**. Then, enter a name and choose an icon. The contextual menu gives also access to additional options such as: **modify the position**, **edit** or **remove**.



R_video On Start-Up

To activate this feature, press **MENU**, then go to **Settings**, click on the **second tab** and switch **ON** the option in the list.

Auto-start

Auto launch R_video on start-up
↑

Filter and Sort

To sort your movies, press **MENU**, then go to Filter and sort. Then click on the **first item**. Then select the sorting: **A to Z**, **Z to A**, **Release date**, **Ranking**, **Duration**, **Addition...** The new sorting bar will appear on the right of the cover list. To filter your movies, please click the following options: **Seen**, **Ongoing**, or **Not seen**.

Filters

 Decreasing Release date
 Seen videos
 Ongoing videos
 Not seen videos

Search Engine

To search for a film, saga, TV show or content with a specific actor or director, click on the **Search** button located in the left bar. Then enter your search (**title**, **actor**, **director**) with a minimum of 3 letters, then validate. The results will be filtered by **films**, **TV shows**, **sagas**, **actors** and **directors**.

Sagas / Groups

The films from sagas are automatically placed in groups and sorted by release date. A saga cover dedicated to the collection is associated with the group and movies are displayed in a dedicated horizontal scroll list.

Subtitle Display Options During Playback

To change the subtitle display options such as vertical position, size and color, press the **Subtitle** button on the Rvolution remote control during video playback, then go to **Settings** and change the desired option. To change the **vertical position**, use the buttons **UP / DOWN**. To change the **size**, use the buttons **P+ / P-**. To change the **color**, use the buttons **1-6**. To add external subtitle, please use the same name as the video file as follows: *Metropolis.mkv / Metropolis.srt*

Subtitle Download Option

To download subtitles, go to the desired movie, concert or episode, then press the **MENU** button on the remote control and click "**Download subtitles...**".

Zoom and Aspect Ratio Settings During Playback

To modify the aspect ratio or zoom the image during playback, press the following button: 

Media Info During Playback

To display the media info and various info such as bitrate, resolution, requery, etc., please press the **INFO** button during playback.

R_video Collection Statistics

If you want to display the statistics of your collection, press the **MENU** button on your remote control, and go to **Information > Collection Statistics**.

Add a Category in the Left Bar

On the R_video home page, go to one of the modules in the left bar. Then, press the **MENU** button on your remote control and select **Add module**. Choose from the list of modules the category you want to highlight in the left bar. You can then modify its position in the left bar if needed.

Token Error Message "Account / token already used"

When you encounter the message **Account / token already used** you need to release the token in order to use it. If you are not able to do it by yourself, contact us by sending us a photo of the sticker under the media player with the token number. We will release it for you.

Firmware Upgrade

Usually, if a new firmware is available, you will be informed at the player's startup. To access the Firmware upgrade page and manually launch the online firmware's update, go to **Setup > Miscellaneous > Firmware Upgrade**. You will see the current firmware version. Click on **Check Available Update**. If a new version is available, you will be able to download it and install it. If there is no new firmware version available, a popup windows will appear to confirm. To manually upgrade the firmware using a USB flash drive, please visit **rvolution.com > Download > Rvolution Player Firmware Updates**.

rvolution.com/knowledgebase



DISCLAIMER

On some cases — especially if you come from a more recent firmware — during the process, the TV screen can switch to **GREEN** or **BLACK** for a while. This is normal! Please absolutely not restart or switch off your player during the full process. In such case, please wait 10 min before to restart your media player.

Factory Reset

In case of problem, try turn OFF your media player and unplug the power cable during 10 min. It could solve the problem. If it does not help, please try the following procedure. Be careful, however. This will reset all your settings and account information. But you will not loose your movie collection.

1. Go to **Setup > General**
2. Click **Reset Settings** button, then click on **Reset settings** to confirm the procedure.
3. Please wait during the reset process.

Warning! Do not restart or switch off your player during the full process

R.volution

rvolution.com / rvolution.store